



Genesis ULTRA

Communication / Music System Installation and Operation Manual

Table of Contents

Important Safety Instructions:	_____	2
System Notes:	_____	3
MagnaLink™ Headset Operation:	_____	4, 5
Technologist Control Unit Operation:	_____	6, 7 & 8
Pre-Installation:	_____	9
System Parts List:	_____	10, 11
Genesis ULTRA Installation and Connections:	___	11, 12, 13, & 14
Rear Panel:	_____	15
Component Locations and Wiring Flow:	_____	16
Installing an older system on a newer GE MRI:	_____	17, 18

Important Safety Instructions

CAUTION

This installation manual is intended for Qualified Field Service Engineers. If you are not thoroughly familiar with ALL MRI SAFETY REQUIREMENTS, Magnacoustics recommends that you DO NOT ATTEMPT THIS INSTALLATION!

- 1) Read these instructions.
- 2) Keep these instructions.
- 3) Heed all warnings.
- 4) Follow all instructions.
- 5) Do not use this apparatus near water.
- 6) Clean only with a dry cloth.
- 7) Do not block any ventilation openings. Install in accordance with the manufacturer's instructions.
- 8) Do not install near any heat sources such as radiators, heat registers, stoves, or other apparatuses that produce heat.
- 9) Do not defeat the safety purpose of the polarized or grounding-type plug. A polarized plug has two blades with one wider than the other. A grounding-type plug has two blades and a third grounding prong. The wide blade or the third prong is provided for your safety. If the provided plug does not fit into your outlet, consult an electrician for replacement of the obsolete outlet.
- 10) Protect the power cord from being walked on or pinched, particularly at plugs, convenience receptacles, and the point where they exit from the apparatus.
- 11) Only use attachments/accessories specified by the manufacturer.
- 12) Use only with a cart, stand, bracket, or table specified by the manufacturer, or sold with the apparatus. When a cart is used, use caution when moving the cart/apparatus combination to avoid injury from tip-over.
- 13) Unplug this apparatus during lightning storms or when unused for long periods of time.
- 14) Refer all servicing to qualified service personnel. Servicing is required when the apparatus has been damaged in any way, such as power-supply cord or plug is damaged, liquid has been spilled or objects have fallen into the apparatus, the apparatus has been exposed to rain or moisture, does not operate normally, or has been dropped.
- 15) Warning - this equipment is not waterproof. To prevent a fire or shock hazard, do not place any container filled with liquid near this equipment (such as a vase or flower pot) or expose it to dripping, splashing, rain or moisture.

Warning: This equipment has been certified to comply with the limits for a Class B computing device, pursuant to Subpart J of Part 15 of FCC Rules. Only peripherals certified to comply with the Class B limits may be attached to this equipment. Operation with non-certified peripherals is likely to result in interference. This equipment generates and uses radio frequency energy and if not installed and used properly, that is, in strict accordance with the manufacturer's instructions, may cause interference. It has been type tested and found to comply with the limits for a Class B computing device in accordance with the specifications in Subpart J of Part 15 of FCC Rules, which are designed to provide reasonable protection against such interference.

Caution: The power switch on this unit will not completely shut off all power from the AC outlet. Since the power cord serves as the main disconnect device for the unit, you will need to unplug it from the AC outlet to shut down all the power. Therefore, make sure the unit has been installed so that the power cord can be easily unplugged from the AC outlet in case of an accident. To avoid fire hazard, the power cord should also be unplugged from the AC outlet when left unused for a long period of time (for example if facility will not be in operation for a few weeks)

This triangle, which appears on your component, alerts you to the presence of uninsulated, dangerous voltage inside the enclosure - voltage that may be sufficient to constitute a risk of shock.



This triangle, which appears on your component, alerts you to important operating and maintenance instructions in this accompanying literature.

System Notes

Our Genesis ULTRA Music System has a number features that need to be fully understood to use this system to its full potential

- Music provides comfort to the patient during the procedure.
- Our MagnaLink™ Pneumatic Stethoscope Style Headsets attenuate gradient noise to patient's ears by 30dB (NRR) Tested per ANSI standard and comply with the GEHC MR Operators Guide.
- DSP technology provides the highest sound quality available for the patient.
- Active volume compensation (Auto Gain) changes volume automatically to help mask MR gradient sounds.
- Patient volume and music selection controls with voice feedback for maximum comfort and versatility.
- Backlit Technologist Control Unit allows operation of the entire system with a touch of the button, even in low-light environments.
- Built-in intercom allows the Technologist to communicate directly with the patient even while the scan is in progress.
- Complete AM-FM stereo, CD and iPod interface.
- Built-in interface for AutoVoice and intercom integration all GE MRIs.
- Built-in Patient Ready Signal (PRS) to signal patients' readiness for the scan to begin.
- Built-in interface for fMRI.
- Built-in interface audio portion of Video.
- 100 % Microprocessor controlled which simplifies operation and programming.

MagnaLink™ Headset & MagnaPlug™ Instructions

- The MagnaLink™ System provides the patient with 30dB of attenuation (NRR) tested per ANSI standard and complies with GE Healthcare’s MR Safety Guide Operator Manual, Revision 7 requirements.
- Because your MRI can produce sound pressure levels that may cause hearing damage, GE Healthcare requires that the Technologist ensure a proper fit of all hearing protection devices.
- Please refer to the detailed instructions below. This procedure will take less than 1 minute to accomplish, assuming the headsets and consumables are readily available and in close proximity to the gantry.

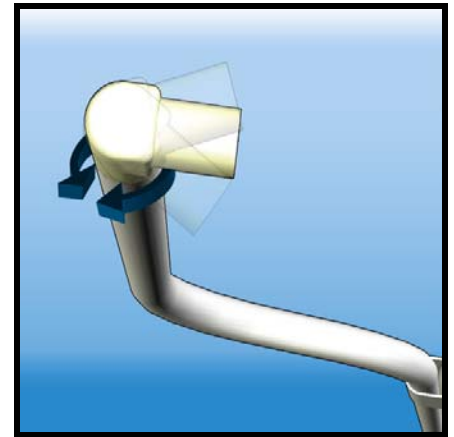
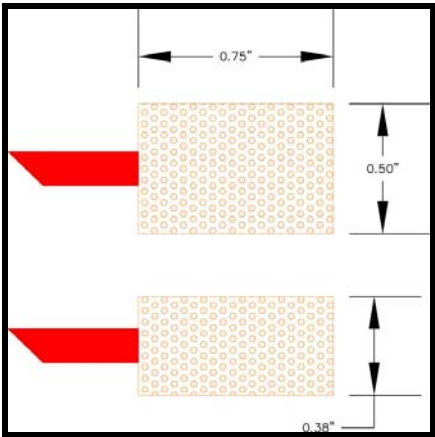

1. There are two sizes of MagnaPlugs available:
 - MagnaPlug .75" X .50" for average size ear canals
 - MagnaPlug Mini .75" X .38" for smaller than average size ear canals
2. The MagnaLink™ “Yoke” will provide a small amount of tension to maintain the MagnaLink to MagnaPlug to patient ear canal connection.
3. The MagnaLink couplers rotate to facilitate alignment of MagnaPlugs with the patient’s ear canals.

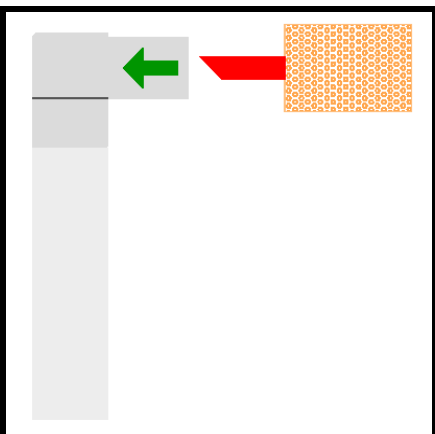

4. Please identify what size MagnaPlug is required for the patient and then insert them into the MagnaLink couplers.
5. Hold the MagnaLink headset in your hands. Using your thumbs and first fingers gently *start rolling*, gradually *increasing pressure*.
6. Roll until you reach the smallest diameter possible. Avoid pinching.

MagnaLink™ Headset & MagnaPlug™ Instructions



7. Insert one side of the headset at a time into the patient's ears. (Best done when the patient is in the supine position)
 8. Hold in place or instruct the patient to hold for about 15 to 20 seconds so that the MagnaPlugs can fully re-expand.
 9. After the scan is completed, discard the MagnaPlugs. Do not attempt to reuse them, they are a disposable item. Ear infections are spread very easily.
10. There is a very good and informative YouTube Video titled "Fitting Foam Earplugs". Please review for help with the proper technique for the insertion of foam earplugs into the ear canal.
<http://www.youtube.com/watch?v=MvG5oVW6FCo>

 **Caution:**

1. **Only use the Magnacoustics MagnaLink™ System with your Magnacoustics Music System.** This will ensure your patients hearing protection with all coils in addition to allowing your system to meet and/or exceed GE Healthcare's attenuation requirements.
2. Use of any other headset with your Magnacoustics MRI Music System will NOT work and may cause serious patient safety issues.
3. **The Magnacoustics MagnaLink™ System was designed for Magnacoustics MRI Music Systems Only.** Use on other non-Magnacoustics Systems may cause serious patient safety issues.

Technologist Control Unit Operation

Terminology: TCU = Technologist Control Unit

- 1: To turn Genesis MRI Music **ON** from TCU push the Green **Power** button (located on the top right corner).
- 2: To adjust Technologist's **Speaker Music Level** depress the Green **TECH VOL+** and the Red **VOL-** (located to the left of the **Power** button) for UP and Down respectively. The Stereo will show the level. To **Mute** the Technologist's **Speakers** depress the Violet **TECH MUTE** button (located under the Red **VOL-** button). The "**ON**" will flash on the mid right side of the display in the **MUTE** box.
- 3: On power up the microprocessor sets **VOL, Mic, and AVC** level for patients wherever it was left when the system was turned off. The number equals the percentage of volume and the horizontal bar gives a quick visual representation.
- 4: Depressing the Green **Mic** button (located on bottom left corner) will allow you to override music and talk to the patients. Level can be adjusted buy depressing Green **Mic VOL+**, or the Red **VOL-**, for UP and Down respectively. A good starting point is 50. When **Mic button** is depressed you will see "Mic" on the lower left "**MODE**" box of the display.
- 5: When the **AVC (intercom integration)** input has triggered from depressing the **Mic** button on your GE Intercom (providing the intercom integration kit was installed) the Display will show **AVC** in the lower left "MODE" box, and the music to the patient will be interrupted. The AVC level and the console intercom level will control the level to the patients (it's a good idea adjust the AVC and, leave the console set the same for a Patient without Headsets.) A good starting point is 50 but no two MRIs are the same.
- 6: Depressing the Red **PAT OVERRIDE** button (located above the **Mic** button) will toggle thru locking out the patient from adjusting the **VOL, SEL, VOL SEL, or OFF**. This will also be displayed on the lower right "**PAT OVR**" box.
- 7: We recommend getting in the habit of depressing the **Red PAT MUTE** button (located above **PAT OVERRIDE** button) after each patient (this way when you are setting up a new patient they will be able to hear you, if the music is on they probably can't.)
- 8: Depressing the Green **VOL NORM** button (located above **VOL OFF** button) will raise Volume for the Patients to 20. This preset is a good starting point and can be adjusted in program mode described in **step 14**.
- 9: Depressing Red **MUSIC VOL-** button (located above the **VOL NORM** button) will lower Volume for the Patients, and depressing the Green **MUSIC VOL+** (located above the **MUSIC VOL-** button) will raise Volume for the Patients.
- 10: The Genesis has a feature called **AUTO GAIN** this provides the ability to automatically adjust volume level of music to Patients dependent on the amount gradient noise being created by MRI.

Technologist Control Unit Operation

- 11: Depending on how loud the Scan Sequence is the **AUTO GAIN** can be turned on and off by depressing the Blue **AUTO GAIN** button (located under the Red **Mic VOL-** button). The **AUTO GAIN** setting can be seen on the upper left corner of the display in the “**GAIN**” box (**Off, Idle, Low, Med, and High**). When the **AUTO GAIN** is active you can also see an ^ to the left of the VOL BAR indicating that it has adjusted the MUSIC LEVEL to the Patient. The percentage can be adjusted to 5%, 10%, 15%, 20%, or 25% per stage in the PROGRAM MODE **STEP 14**.
- 12: Depressing the Blue **COMP** button (located under the Blue **AUTO GAIN** button) will provide a more even flow of Music to the Patient, by raising the lows and lowering the highs.
- 13: All the other buttons control the Stereo.
- 14: Depressing the Blue “**PROGRAM**” button (located below the red **AVC VOL-** button) will put the system in “Program Mode. Depressing the **MUSIC VOL+** and **VOL-** button toggle up and down through the Menu respectively. Depressing the Blue / Green **INPUT/ENTER** button (located bellow the Blue **PROGRAM** button) will toggle the options in the menu that is highlighted. Depressing the **PROGRAM** button again will memorize any changes you have made and exit the Program Mode. (Use Page 8 for visual reference of button locations)

BOLD text indicates the Default Settings.

Tree of programming options:

1. Equalizer:	YOKE 1	YOKE 2	MAGNAMUFF	MAGNAPLUG	FLAT	
2. Gain Increment:	5%	10%	15%	20%	25%	
3. Gain Dwell Time:	2Sec	4Sec 6Sec				
4. Initialization:	TUNER	VIDEO FMRI		USB	iPod	CD
5. Volume Norm Set:	20	30 40		50		
6. Volume Gain Set:	LOW	NORM	HIGH			
7. Bass:	LOWEST	LOW	NORM	HIGH HIGHEST		
8. Treble:	LOWEST	LOW	NORM	HIGH HIGHEST		
9. Contrast:	MIN	2, 3,4,5,6	7, NORM 9,10,11,		12,13,14,	MAX
10. Keypad Click:	NORM	OFF				
11. Ambient MIC Level	Set					
12. Scan MIC Level	Set					
13. Boot Mode	Norm	Diagnostic				
14. FMRI	Pulse High	Pulse Low	High Held	Low Held		
15. IR Remote	JVC UXGN6	JVC MXKC58				
16. IR Remote Dwell	1Sec	2Sec 3Sec		4Sec		

Technologist Control Unit Operation

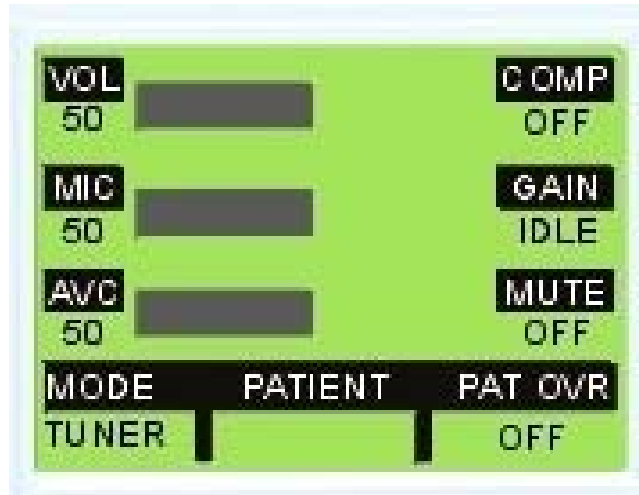

Pre-Installation

Mean Time to Install

Allow 3 man-hours for unpacking, installation, checking and setting up of Genesis ULTRA MRI Music System.

Additional time may be required when difficult ducting of cables is encountered.

Recommended service tools for installation:

1. Nut Driver set
2. Pliers
3. Screw Drivers
4. Razor Knife
6. Electrical Tape
7. 100 ft. Electrical Snake (fish tape)

System Parts List

Genesis ULTRA is supplied complete with all necessary cables to simplify quick installation. After unpacking, check for the following items:

- 1: AM/FM Stereo, CD, with iPod Interface.
- 2: One AM antenna.
- 3: One FM antenna.
- 4: Two Speakers.
- 5: One Transducer Module (houses connections for Headset, Patient Volume control, Patient selection control, and Mic connection for Active volume stabilization.)
- 6: One Gradient Mic (Blue cable with BNC and Black Mic.)
- 7: One Clear Siamese Headset tubing to (Link Transducer to Headset.)
- 8: One MagnaLink™ Headset and 200 pairs of MagnaPlugs™ (earplugs).
- 9: Patient volume control Red and Green buttons.
- 10: Patient selection control Blue and Yellow buttons.
- 11: CB1 - 90 ft. DB9 Female to Male DB9 Cable (Links Genesis Ultra module to Penetration Panel.)
- 12: CB2 - 50ft. DB9 Female to Female DB9 Cable (Links from Penetration Panel to Transducer.)

System Parts List - continued

- 13: CB3 - 10ft. DB9 to Male AMP Cable (Links Breakout Box to Genesis Ultra module.)
- 14: CB4- 3ft DB25 to DB25 Cable (links Breakout Box to AutoVoice board.)
- 15: CB5- 6ft stereo 3.5mm (links audio from the Stereo to Genesis Ultra module.)
- 16: CB6- 6ft 4 conductor cables (links the speaker terminals on the Stereo to speaker terminals on the Genesis Ultra module **Not used with JVC UX-GN6 After May 2009**)
- 17: CB7- 6ft 3.5mm to IR Emitter (connects to Genesis Ultra module and sticks over IR receiver on the Stereo prior to JVC UX-GN6) 6ft 3.5mm to 3.5mm Remote Control Link (**Used with JVC UX-GN6 After May 2009**)
- 18: CB8- 6ft AC Adapter Cable (connects the AC Outlet to the Switched, Voltage Selectable, and Fused AC Receptacle on the rear of Genesis Ultra module.)
- 19: AutoVoice Breakout Box (intercom integration box.)
- 20: DB9 RF Filter (attaches to penetration panel.)
- 21: DB9 RF Filter adapter plate (to be used on MRIs that do not have a spare DB9 slot.)
- 22: Technologist Control Unit (System Remote Control.)
- 23: Gradient noise sensing Mic (with 10 ft. cable for AGC.)
- 24: (5) Zip Ties and 5 mounting pads to dress cables.
- 25: Stereo remote control.
- 26: Intercom Mic.
- 27: Genesis Ultra Module.

Genesis ULTRA Installation and Connections

Refer to Stereo Manual for Illustrations and for identification of controls.

CAUTION

Ensure that AC cords from the Stereo and Genesis Ultra module are not connected to power source until all connections are completed. Also ensure that the power entry receptacle is set up for your voltage 110 / 220

Use Page 15 & 16 for J# Illustrations

- 1: Place Genesis Ultra module and as close to operator's console as possible, the floor is permissible. Place the Stereo on the work station or as close as possible.
- 2: Place Technologist Control Unit on operator's console and connect cable from Technologist Control Unit to **J8** on the rear of Genesis Ultra module.
- 3: Place the speakers on the floor beside the console or other suitable location out of the way.
- 4: Pre JVC UX-GN6, connect speaker cables to the lower 4 terminals of **SPK 1** on the Genesis Ultra module. Observe polarity. With JVC UX-GN6 connect the speaker cables to back of stereo; "CB6" is not used.
- 5: (Skip to step 6 if using JVC UX-GN6 Stereo after May 2009 Serial #181335ML or higher) Connect one side of cable "CB6" 6ft 4-conductor cable to the speaker terminals on the back of the Stereo Red and Black to Left Red and Black, Green and White to Right Black and Red respectively, the other side of cable "CB6" to the upper terminals of **SPK1** on the rear of Genesis Ultra module. **Follow the same colors and polarity as you did with the Stereo.**
- 6: Connect one cable "CB5" 6ft stereo 3.5mm to **J1** on the rear of Genesis Ultra module, and the other side to **J1** on the rear of the Stereo.
- 7:
 - a. If JVC UX-GN6 is used after May 2009 (Serial #181335ML or higher) Connect one side of CB7 to **J7** on Genesis Ultra module the other side to **J7** on the rear of the stereo.
 - b. If prior to May 2009 (Serial #181334 or lower); Connect cable "CB7" 6ft 3.5mm to IR Emitter plug to the **J7** on the rear of Genesis Ultra module. Remove the protective paper from the back of the red IR transmitter and place it over the IR detector that is located about 1/4" to the right of "CD2" label on the JVC MHC Stereo.

Caution: CB5 and CB6 look alike, please do not misconnect! (CB5 to J1 and CB6 to J7)

- 8: Place the Intercom Mic on the Operators Console and plug the cable into **J4** on the rear of Genesis Ultra module. Make sure the MIC slide switch on stalk is turned on.

If you are installing the Intercom Integration Kit follow steps 9 – 13, if not go to step 14

- 9: Connect the round AMP end of "CB3" 10ft. DB9 to Male AMP Cable to **J6** on the rear of Genesis Ultra module.
- 11: Connect the DB9 end of "CB3" to the DB9 on the AutoVoice Breakout Box.

Genesis ULTRA Installation and Connections - continued

For Excite or newer systems go to step 13, For MR750 go to step 14

- 12: For Horizon LX locate **Run 788** and remove the DB25 from **J7** on the WIM Module and connect to the DB25 on the AutoVoice Breakout Box, then connect “CB4” to the other DB25 on AutoVoice Breakout Box, and connect the other end of “CB4” to **J7** on the WIM Module.
- 13: For Excite or newer systems locate **Run 1085** labeled **OW1-A21-J7** and remove the DB25 from **J7** on the Wim Module and connect to the DB25 on the AutoVoice Breakout Box, then connect “CB4” to the other DB25 on AutoVoice Breakout Box, and connect the other end of “CB4” to **J7** on the WIM Module.
- 14: For MR750 systems locate **Run 3031** and remove the DB25 from **J7** on the Audio Board in the GOC and connect to the DB25 on the AutoVoice Breakout Box, then connect one side of cable “CB4” to the other DB25 on AutoVoice Breakout Box, and connect the other end of “CB4” to **J7** on the Audio Board.
- 15: Connect the female side of cable “CB8” 6ft AC Adapter Cable to **J12** on the rear of Genesis Ultra module. Ensure that the power entry receptacle is set up for proper voltage either 110 or 220 default is 110. **CAUTION:** Please ensure that all connections are complete before connecting AC power cord.
- 16: Connect FM and AM Antenna to the Stereo. Reference Antenna Connections in the Stereo Instructions for proper installation of FM / AM Antenna.
- 17: For GE MRI’s remove block off plate from J53 or J52 at penetration panel. All others use supplied kit or fabricate a DB9 slot for filter as required.
- 18: Install RF filter with **female toward computer room**.
- 19: Locate existing electrical conduit between control console and computer room.
CAUTION: Assistance may be necessary to ensure Trauma free installation of cable CB1
- 20: Route and install Cable “CB1” (90 ft. DB9 Male to Female) with Female connector toward Genesis Ultra module and Male toward penetration panel.
- 21: Connect “CB1” Male to the RF filter.
- 22: Zip tie cable “CB1” to existing supports, or cables from penetration panel to provide strain relief.
- 23: Connect Female end of cable “CB1” to **J11** on the rear of Genesis Ultra module.
- 24: From the scan room side of penetration panel, connect cable “CB2” (50ft. DB9 Female to Female) to the RF filter you installed on penetration panel.
- 25: Zip tie cable “CB2” to existing cables from penetration panel to provide strain relief.
- 26: Route cable “CB2” on opposite side of the cold head (if used) to the front of the MRI utilizing existing conduits.

Genesis ULTRA Installation and Connections - continued

- 27: Leave approximately 18" of cable "CB2" protruding from the front center of the MRI directly above the table docking mechanism for a service loop, or alongside the base of the gantry. It is important to locate the end of "CB2" as close as possible to the front center of the bore.
- 28: For all MRI's it is very important to locate the Transducer as close as possible to the front center of the bore. For all GE MRI's locate the Transducer either side of the pedestal above the Up / Down height control peddles as pictured below. Connect cable "CB2" to the Transducer.

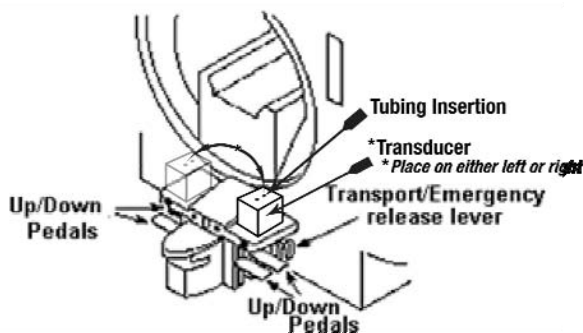

- 29: There are very sensitive pressure actuated switches for the patient controls located in the Transducer. During shipping sometimes pressure or vacuums can build in the controls causing erroneous operation of the patient volume and mode selection buttons. Therefore it is good practice to let the Controls and Transducer become acclimated to the scan room environment for a few hours or until the temperature stabilizes then;
- Vent the patient controls to the atmosphere by momentarily removing the white tubing one pair at a time and reconnecting them to the nipples on the Transducer observing polarity for proper synchronization.
- 30: Insure that the Gradient noise sensing Mic is connected to the BNC connection on the side of Transducer. Place the Mic anywhere in the general area. Secure with the provided mounting pad and zip tie.
- 31: Connect the clear Siamese Headset tubing to the brass tubes protruding from the top of Transducer. **Do not add any additional tubing length to this system, doing so will adversely affect performance and reliability.**
- 32: Connect the Headset to Siamese tubing.
- CAUTION:** Please ensure that all connections are complete before connecting AC power cord.
- 33: Connect power cord from Stereo to AC receptacle 120V / 15 Amp minimum.
- 34: Connect the plug side of "CB8" to AC receptacle 120V / 15 Amp minimum.
- 35: Look at the front panel of the Genesis and ensure the all-8 red LED's are lit under Circuit A Power and Circuit B Power. If not, unplug the AC power cords and contact Magnacoustics Tech Support at 1-800-637-2282 or E-mail at support@magnacoustics.com for assistance.

Genesis ULTRA Installation and Connections - continued

- 36: Press the green Power Button on the TCU a self-test will complete and the system should power up in Tuner mode. (It may be necessary to adjust the FM antenna to get better reception. Please keep in mind that if the MRI is located in the basement or if most of the transmitting Radio stations are separated by the Scan Room RF Shielding, some form of auxiliary or external antenna might be required.
- 37: After making sure the Stereo is playing ok (with Tuner, iPod or CD selected). Depress the Green **VOL NORM** button and go into the Scan Room to ensure there is music playing from the Headsets. (If you have help depress the Green **Mic** button speak into the supplied Mic (make sure the Mic mute switch is off) to ensure intercom operation.

Auto Gain Calibration Procedure

- 38: In order to calibrate the **Microprocessor for AUTO GAIN Function** it will be necessary to program the Ambient and Full Scan SPL levels, the please follow this procedure;
 - a. Depress the Blue **PROG MODE** button once.
 - b. Depress the **MUSIC VOL-** button to toggle down till 11. Ambient MIC Set is highlighted.
 - c. Depress the **INPUT/ENTER** button once and then again allowing the Auto Gain Mic to capture the SPL in the room with the scanner idle.
 - d. Depress the **MUSIC VOL-** once to highlight 12. SCAN MIC Level Set depress the **INPUT/ENTER** once.
 - e. Set up a Phantom and start the Scanner for and average scan (Full Scan Level).
 - f. Depress the **INPUT/ENTER** one more time to capture the SPL in the room with the scanner active.
 - g. Depress the Blue **PROG MODE** once (which will store the two extremes) and let the Microprocessor calculate how much Auto Gain in necessary.

CAUTION: Please do not connect any external Antenna or Audio input to the stereo without the proper isolation. We use the Scan Room Shielding as our ground reference. Any auxiliary connection to the stereo might not have the same ground potential causing a 60 cycle hum from the speakers or patient headset. This difference in ground potential my also cause system damage.

1. Radio Shack Ground Loop Isolator Catalog #: 270-054 with the proper phono to 3.5mm stereo adapter Radio Shack Catalog #: 274-883 and xx adapter or equivalent must be used.
2. A 75 to 300 ohm adapter in series with the any external antenna source must be used.

Rear Panel Genesis ULTRA

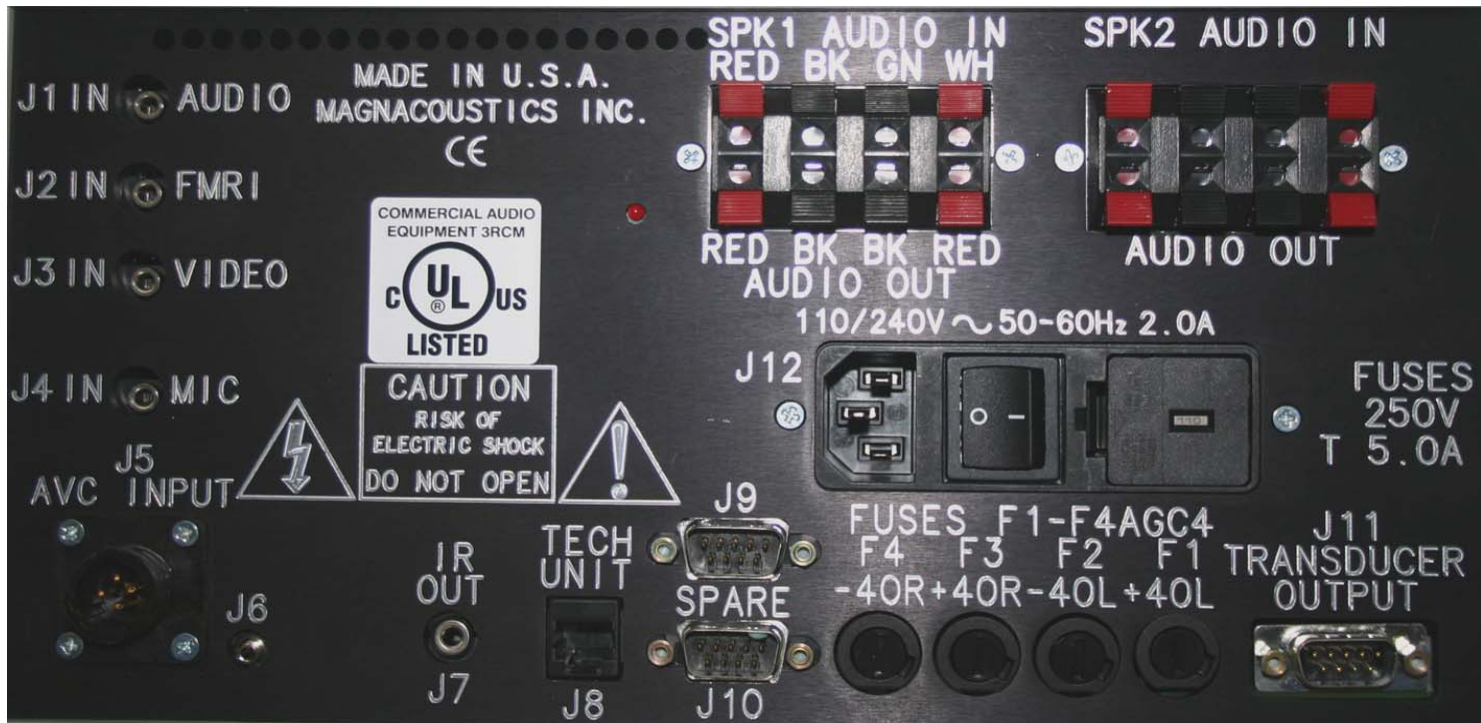

J1= Audio Input from Stereo

J2= fMRI Input

J3= Video Input

J4= MIC Input

J5= AVC Input

J6= fMRI trigger output

J7= IR Output to Stereo/TTL PRS output

F1, F2, F3, & F4= 4.0 A SB J11 ISO T5.0 A

J8= Tech Unit Connector

J9= RS232 Spare

J10= RS 232 Spare

J11= To Transducer "CB1"

J12= AC Receptacle 5 amp SB

SPK1= Speaker Junction for Mute *

SPK2= Spare Speaker Junction *

* Not used after Serial #181335

Component Locations and Wiring Flow

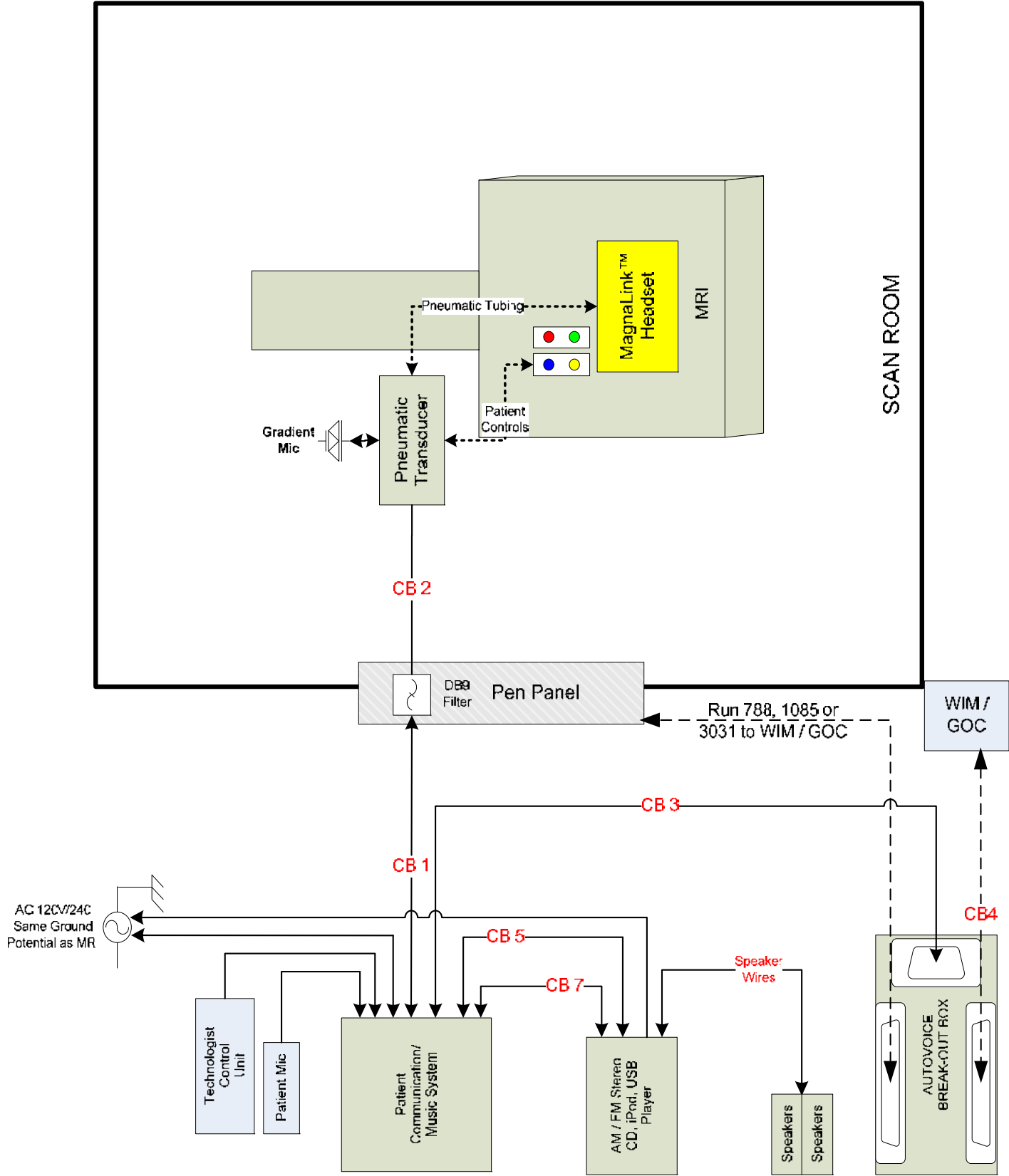

Directions for installing or re-installing an older Magnacoustics system on a newer GE MRI

If the serial number of your Magnacoustics system is below 18904 and you are installing or re-installing this system on an Excite, HD, HDE, HDX, HDXT, MR750 or newer MRI, a cable pin-out upgrade might be required. To determine if the upgrade is necessary, complete this install according to the previous instructions. Depress the GE console **Mic** button while observing the lower left hand corner of the display on our Technologist Control Unit; “AVC” should appear. If “AVC” does not appear, then the upgrade will be required. (Please Note: Magnacoustics Serial #18904 shipped in July of 2006)

Mean Time to Upgrade;

Approximately 15 minutes

Tools required;

#2 Philips

Small pin-poker or small screwdriver

Please follow the Important Safety Instructions on page 2 and confirm that the power cord is removed from the power entry module before proceeding to Step 1

Directions for installing or re-installing an older Magnacoustics system on a newer GE MRI continued

1. Depress the 4 gray buttons around the upper perimeter of the Genesis Ultra module, releasing the 4 pop-up tabs on the top of the chassis that conceal the securing screws.
2. Remove the 4 larger screws with the #2 Philips and set aside.
3. The module separates like a clam shell, use an even force pulling up on the top section alternating between the left and right side repeatedly until the top is free and set aside.
(Please Note; Be Sure the front face stays with the bottom half of the chassis)
4. Look towards the back right of the chassis, use this pictorial to locate the cable going to J5 remove the molex connector and using pin-poker depress tab to release pins, upgrade / reconfigure to this spec.

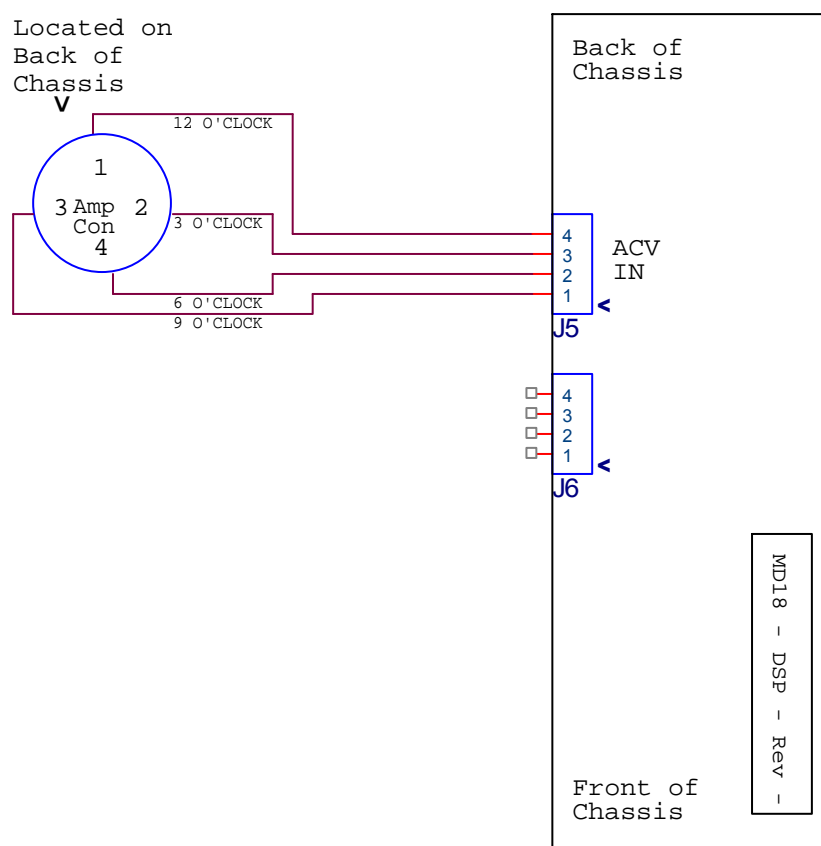

5. Reassemble by reversing steps 3 and 2 then depress the popup tabs on the top of the chassis.
6. Reconnect all wires and confirm that AVC appears in the lower left hand corner of display on our Tech. Unit when the GE console Mic button is depressed.
7. If you require any further assistance please contact Magnacoustics Technical Support @ 800-637-2282 (9am to 5pm M-F EST).